

# ESK116V-XXP

PCB Terminal Blocks &gt; PCB Terminal Blocks

Date:2023-03-14Version:1.1

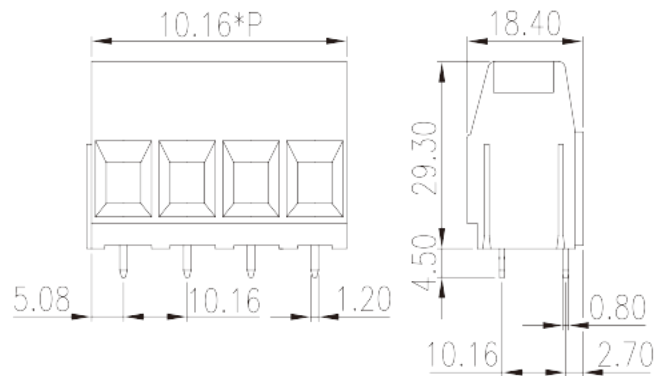
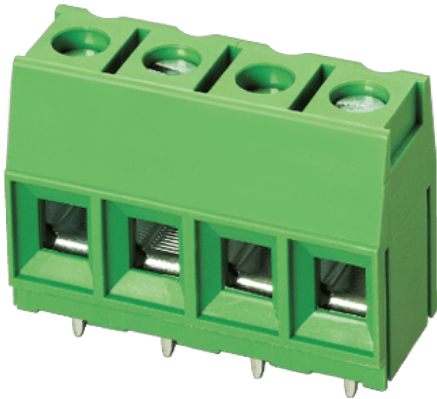

The web catalog is for reference only. Dinkle remains the right of product modification and engineering change of the design. The final product is made according to engineering drawing.

## Product Description

Pitch : 10.16mm, 300/600V, 65/5A

## General information

Short description	PCB Terminal Blocks, Screw Connection
Category	PCB Terminal Blocks
Pitch (mm)	10.16
Color	Green (default)
Connection method	Screw Connection
Type of locking	Without
Length (mm)	$10.16 \times (P-1) + 10.16$
Width (mm)	18.4
Height (mm)	29.3
Pin demensions (Thickness x Width)(mm)	0.8x1.2
PCB hole diameter (mm)	1.6
Number of positions	02P~16P
Level	Single level

## Material information

Insulation material	PA
---------------------	----

Insulation material group	I
Flame retardant rating , compliant with UL94	V0
Insulation resistance	□500MΩ at DC 500V
Conductor material	COPPER ALLOY
Plating of conductor surface	Tin PLATED

## Connection data-IEC

Rated voltage (V)	1000
Rated current (A)	76
Rated voltage (II/2)(V)	1000
Rated voltage (III/2) (V)	1000
Rated voltage (III/3)(V)	800
Rated impulse voltage (II/2)(KV)	8
Rated impulse voltage (III/2)(KV)	8
Rated impulse voltage (III/3)(KV)	8
Conductor cross section solid. min (mm <sup>2</sup> )	0.5
Conductor cross section solid.max (mm <sup>2</sup> )	16
Conductor cross section stranded. min (mm <sup>2</sup> )	0.5
Conductor cross section stranded. max (mm <sup>2</sup> )	16
Conductor cross section flexible, with min ferrule without plastic sleeve (mm <sup>2</sup> )	0.25
Conductor cross section flexible, with max ferrule without plastic sleeve (mm <sup>2</sup> )	10
Conductor cross section flexible, with min ferrule with plastic sleeve (mm <sup>2</sup> )	0.25
Conductor cross section flexible, with max ferrule with plastic sleeve (mm <sup>2</sup> )	10
2 conductors with same cross section, solid, min (mm <sup>2</sup> )	0.5
2 conductors with same cross section, solid, max (mm <sup>2</sup> )	4
2 conductors with same cross section, stranded, min (mm <sup>2</sup> )	0.5
2 conductors with same cross section, stranded, max (mm <sup>2</sup> )	4
Screw thread	M4
Slotted screwdriver size (Blade thickness x Width)(mm)	0.8x4.0
Recommend tightening torque. min (N.m)	1.2
Recommend tightening torque. max (N.m)	1.5

Stripping Length (mm)	10~11
-----------------------	-------

## Connection data-UL

Rated voltage (UL/CUL Group B)(V)	300
Rated current (UL/CUL Group B)(A)	65
Rated voltage (UL/CUL Group C)(V)	300
Rated current (UL/CUL Group C)(A)	65
Rated voltage (UL/CUL Group D)(V)	600
Rated current (UL/CUL Group D)(A)	5
Min. solid wire connection (AWG) acc. to UL/CUL	6
Max. solid wire connection AWG acc. to UL/CUL	20
Min. stranded wire connection AWG acc. to UL/CUL	6
Max. stranded wire connection AWG acc. to UL/CUL	20

## Environment & Safety

Finger protection (YES or NO)	YES
Operating temperature. max (°C)	120
Operating temperature. min (°C)	-40

## UL Recognized

Wire Range (Group B)(AWG)	20~6
Rated voltage (Group B)(V)	300
Rated current (Group B)(A)	65
Wire Range (Group C)(AWG)	20~6
Rated voltage (Group C)(V)	300
Rated current (Group C)(A)	65
Wire Range (Group D)(AWG)	20~6
Rated voltage (Group D)(V)	600
Rated current (Group D)(A)	5

## CUL Recognized

Wire Range (Group B)(AWG)	20~6
Rated voltage (Group B)(V)	300
Rated current (Group B)(A)	65
Wire Range (Group C)(AWG)	20~6

Rated voltage (Group C)(V)	300
Rated current (Group C)(A)	65
Wire Ranget (Group D)(AWG)	20~6
Rated voltage (Group D)(V)	600
Rated current (Group D)(A)	5

## VDE Approval

Wire Range (mm <sup>2</sup> )	0.5~16
Rated voltage (V)	1000
Rated current (A)	76

## Drawings

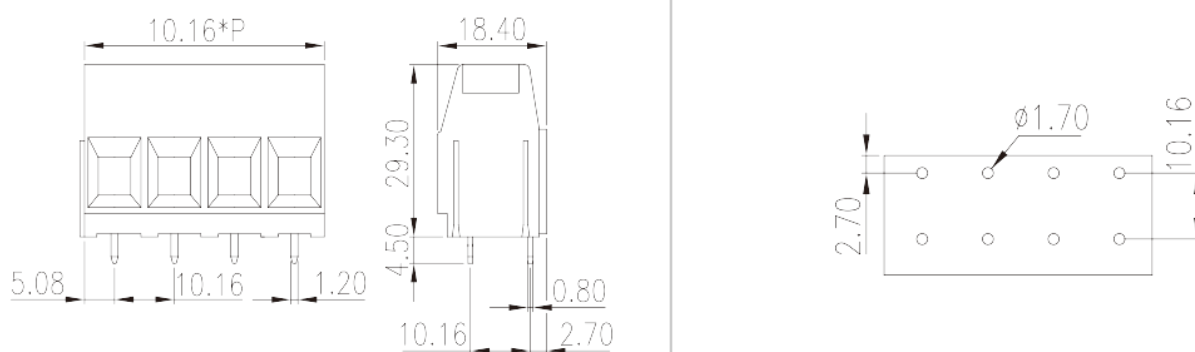

## Approvals

